

6" Half Round Reverse Bead Gutter

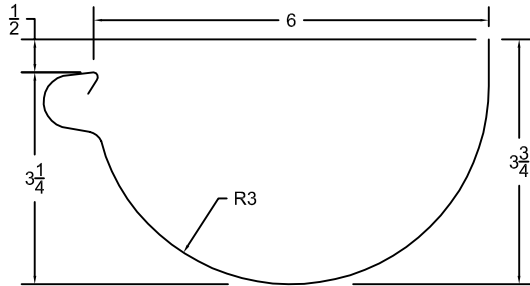

Available Materials;
032, .040 & .050 Kynar Aluminum
.032, .040 & .050 Mill Finish Aluminum
16oz, 20oz Copper & Lead Coated Copper
Zinc
26GA, 24GA & 22GA Kynar
24GA & 26GA Stainless Steel

6" Half Round Paint to Match Cradle Hanger

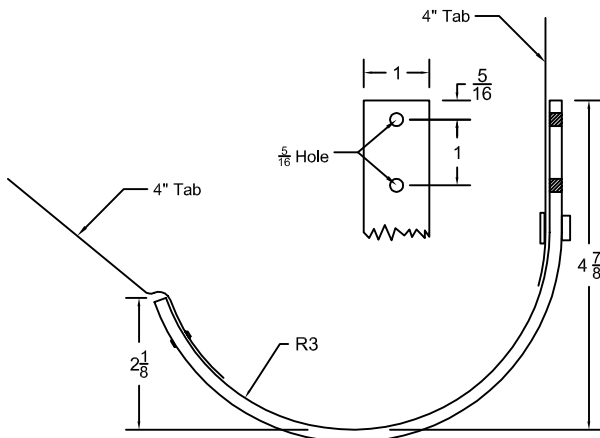

$\frac{3}{16}$ " G90 Galvanized Bar with Pressed Groove
Superior Acrylic Urethane Enamel Paint to Match
Recommended Spacing is 24" o.c.
Front and rear tabs for quick and easy installation

**Hand Cut End Cap
From Matching Material**

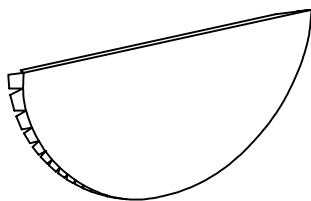

**Inside & Outside
Miter**

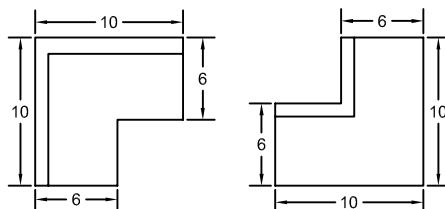

**Hidden Hanger
Stainless Steel**

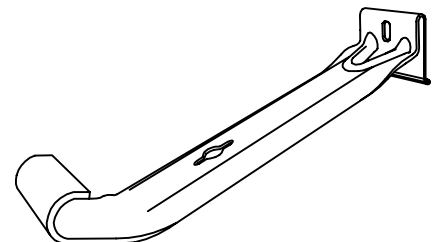

**Optional*

Available Materials;
032, *.040 & *.050 Kynar Aluminum, *.032, *.040 & *.050 Mill Finish Aluminum, 16oz, 20oz Copper & Lead Coated Copper
Zinc. 26GA, 24GA & *22GA Kynar, *24GA & *26GA Stainless Steel ~ *Material not available for elbow

Hand Cut Outlet
From Matching Material

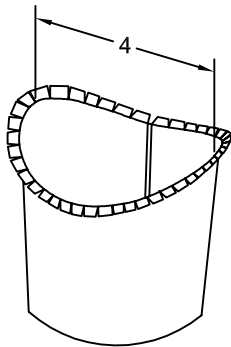

Round Downspout
10' Sections

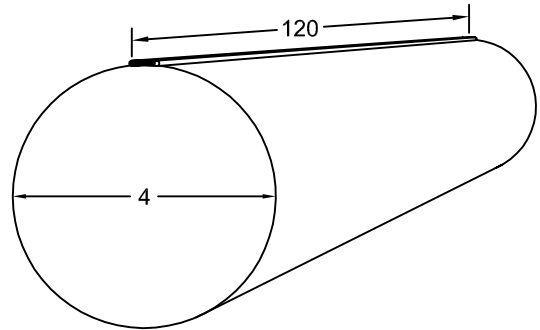

Round Elbow
032 or 24GA

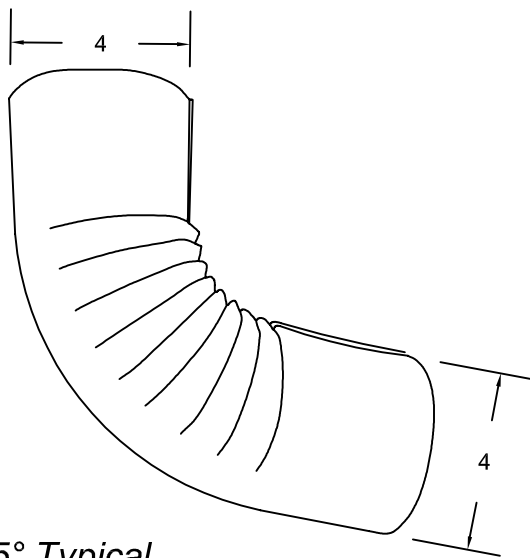

Pre-rolled
Downspout Strap

