

1.0 STANDARD TRIM

MATERIAL (please choose one):

- | | | |
|--------------------------------------|--------------------------------------|------------------------------------|
| <input type="checkbox"/> 26 GA Steel | <input type="checkbox"/> 22 GA Steel | <input type="checkbox"/> .040 Alum |
| <input type="checkbox"/> 24 GA Steel | <input type="checkbox"/> .032 Alum | <input type="checkbox"/> .050 Alum |

Color: _____ Finish: _____

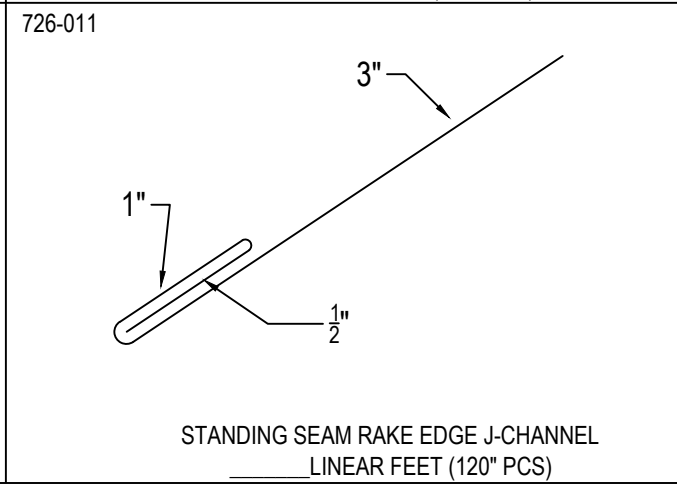
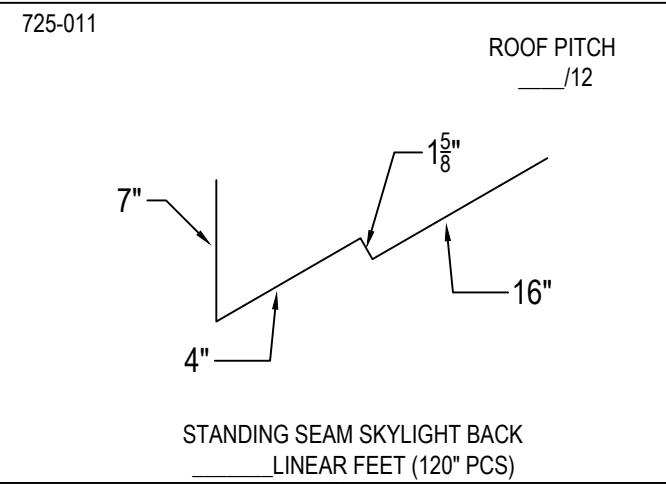
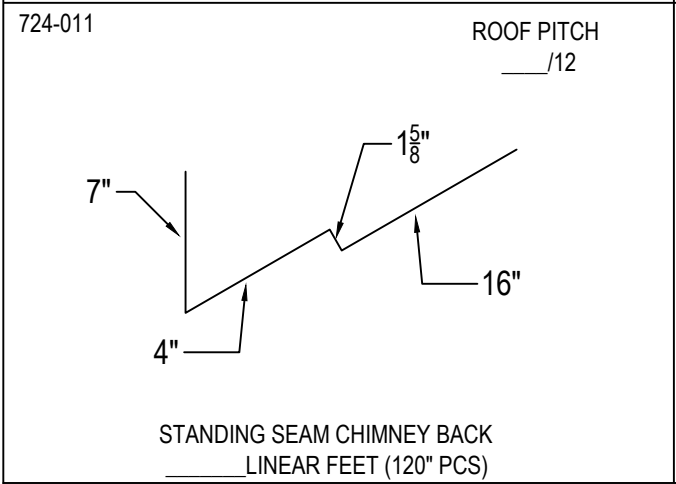
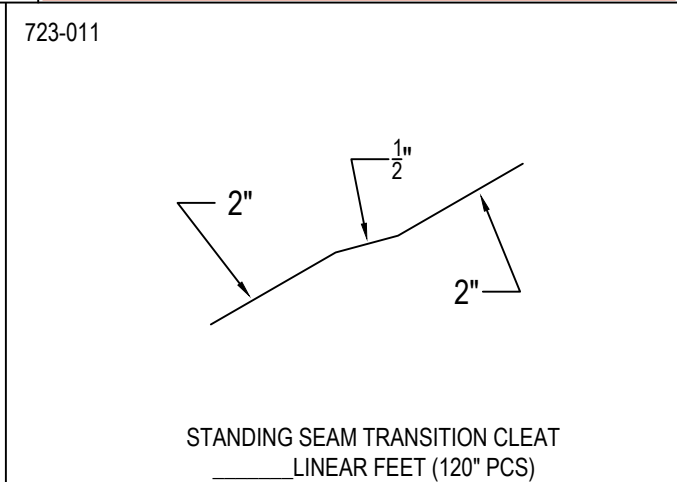
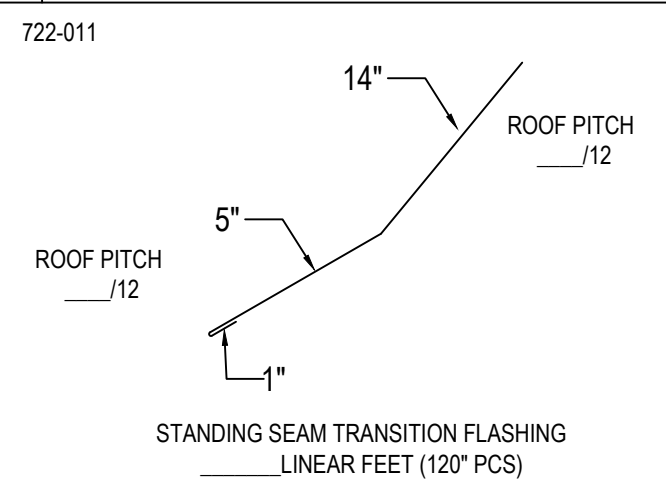
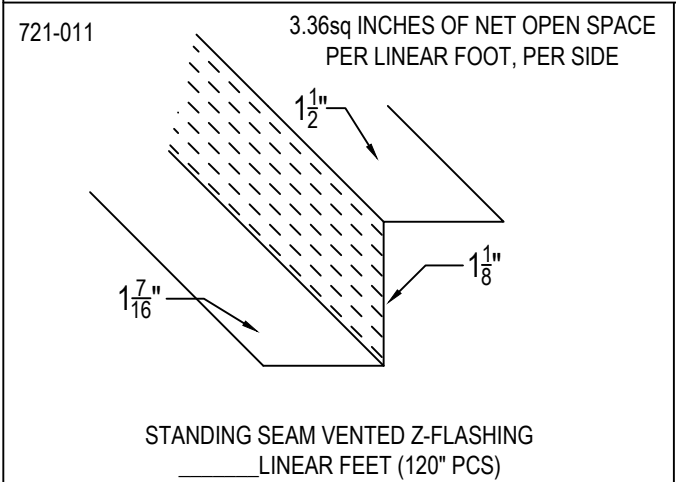
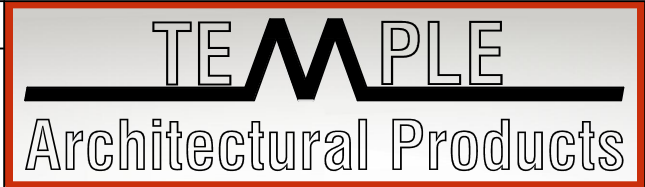

Notes:
 1) Ship To Address: _____
 City: _____ State: _____ Zip: _____
 2) Written approval is required prior to fabrication, contractor is responsible for all dimensions and quantities. Fabricated items are not returnable.

Project Name: _____
 Installing Contractor: _____
 Contact Name: _____
 Contact number: _____
 Signed Approval: _____

Sheet ___ of ____ DWG# 720-011

Temple Architectural Products
 1111 Lowell St.
 Elyria, Ohio 44035

(440) 323-9393
 Estimates@templearchitecturalproducts.com
 www.templearchitecturalproducts.com