

2.0 STANDARD TRIM

MATERIAL (please choose one):

- | | | |
|--------------------------------------|--------------------------------------|------------------------------------|
| <input type="checkbox"/> 26 GA Steel | <input type="checkbox"/> 22 GA Steel | <input type="checkbox"/> .040 Alum |
| <input type="checkbox"/> 24 GA Steel | <input type="checkbox"/> .032 Alum | <input type="checkbox"/> .050 Alum |

Color: _____ Finish: _____

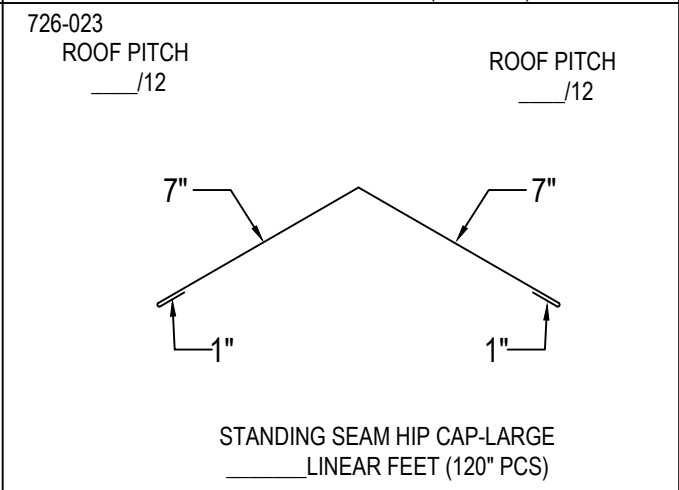
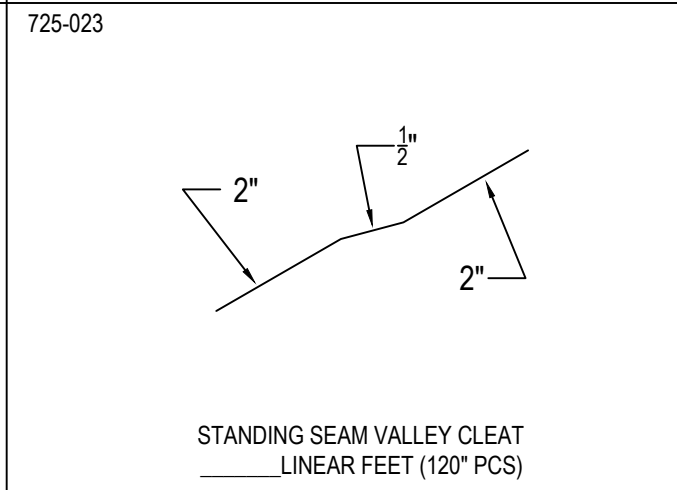
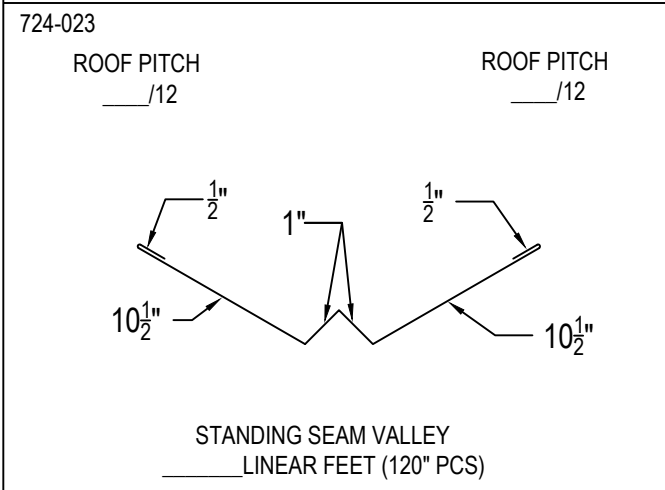
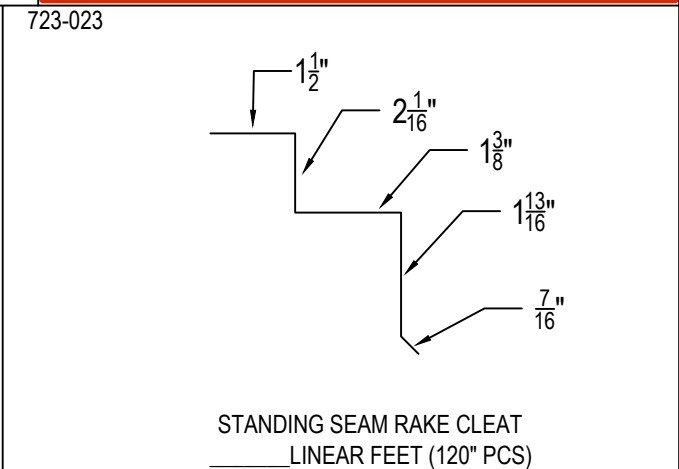
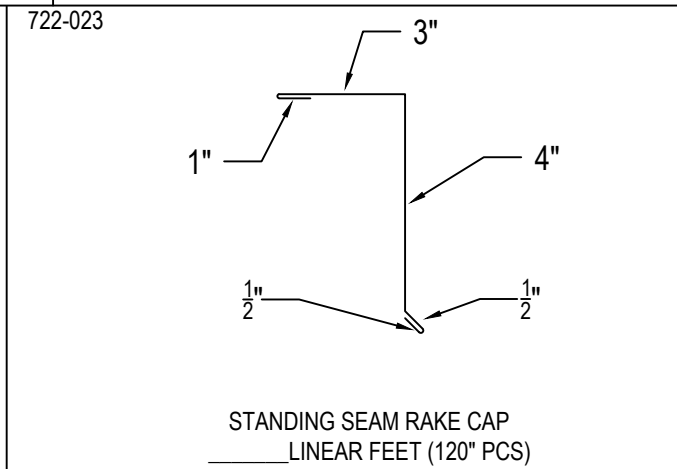
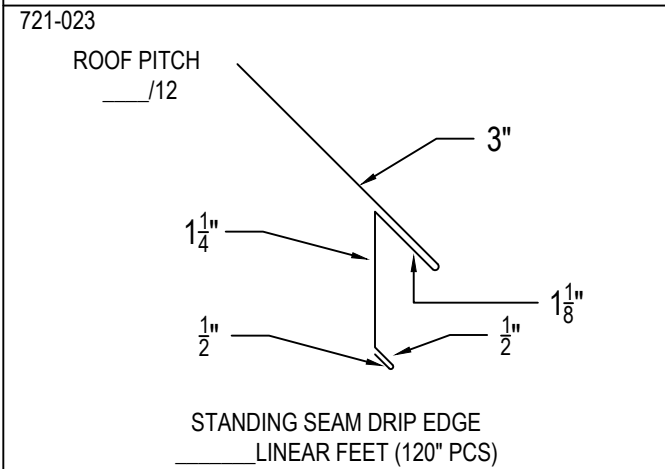

Notes:

1) Ship To Address: _____
City: _____ State: _____ Zip: _____

2) Written approval is required prior to fabrication, contractor is responsible for all dimensions and quantities. Fabricated items are not returnable.

Project Name: _____

Installing Contractor: _____

Contact Name: _____

Contact number: _____

Signed Approval: _____

Sheet ____ of ____ DWG# 720-023

Temple Architectural Products
1111 Lowell St.
Elyria, Ohio 44035

(440) 323-9393
Estimates@templearchitecturalproducts.com
www.templearchitecturalproducts.com