

RADIUS RAKE EDGE - OPTION 2A

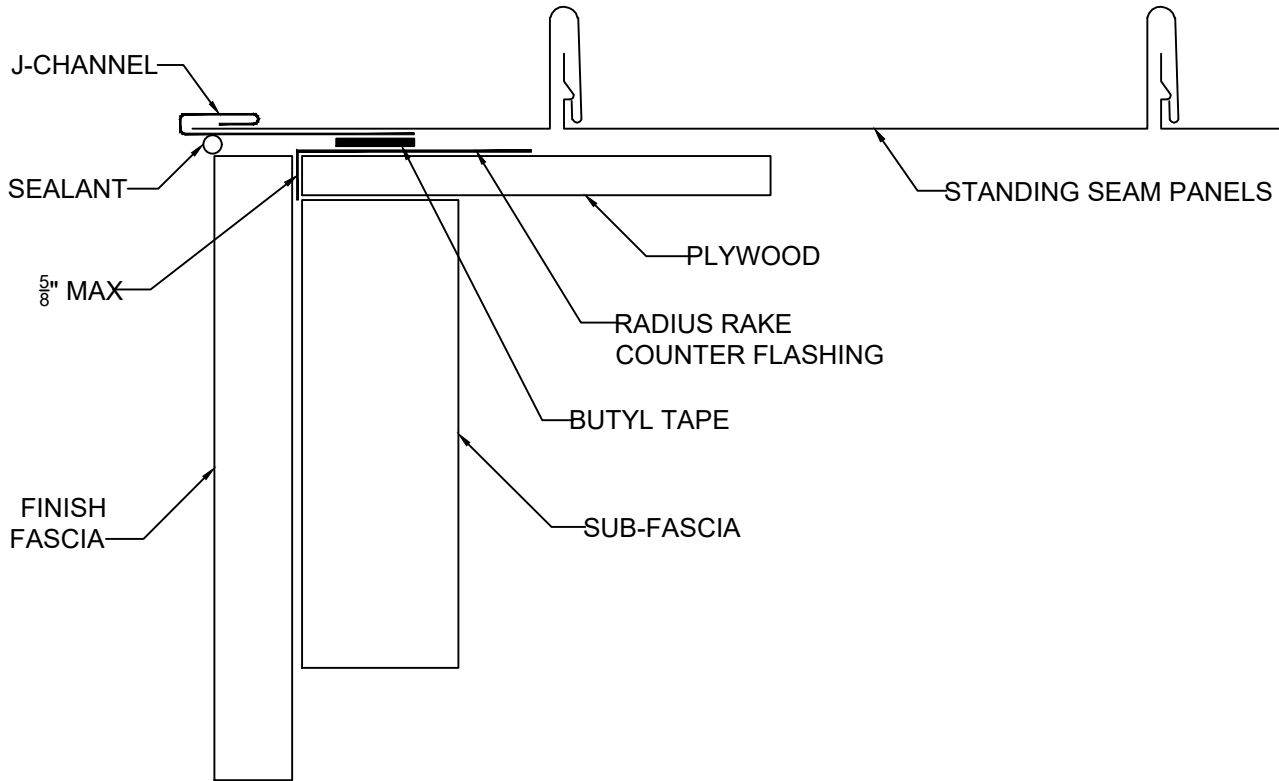
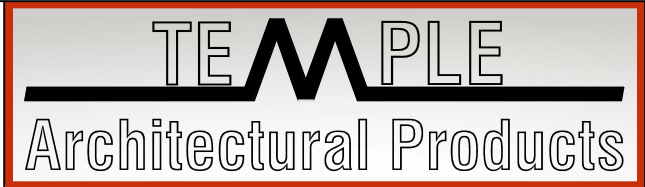

MATERIAL (please choose one):

- | | |
|--|--|
| <input type="checkbox"/> 26 GA Steel | <input type="checkbox"/> .040 Aluminum |
| <input type="checkbox"/> 24 GA Steel | <input type="checkbox"/> .050 Aluminum |
| <input type="checkbox"/> .032 Aluminum | <input type="checkbox"/> .063 Aluminum |

Other: _____
 Color: _____
 Finish: _____

NOTES / COMMENTS:

Sheet ___ of ___. OPTION 2A

Notes:

- 1) Accessory Welding is only available in .040 aluminum or heavier.
- 2) Written approval is required prior to fabrication, contractor is responsible for all dimensions and quantities. Fabricated items are not returned.

Project Name: _____

Installing Contractor: _____

Contact Name: _____

Contact number: _____

Signed Approval: _____

Temple Architectural Products
 1111 Lowell St.
 Elyria, Ohio 44035

(440) 323-9393
 Estimates@templearchitecturalproducts.com
 www.templearchitecturalproducts.com